

Technische Daten: Art.-Nr.: 870825

Wandaußenmaß: 390 x 390 cm

Bohlenstärke: 70 mm



Trondheim 70-D XL

Kontrolliert durch:

Empty box for signature or name.

Achtung: Alle angegebenen Maße sind ca.-Maße!

3D-Darstellung und Grundriss 870825

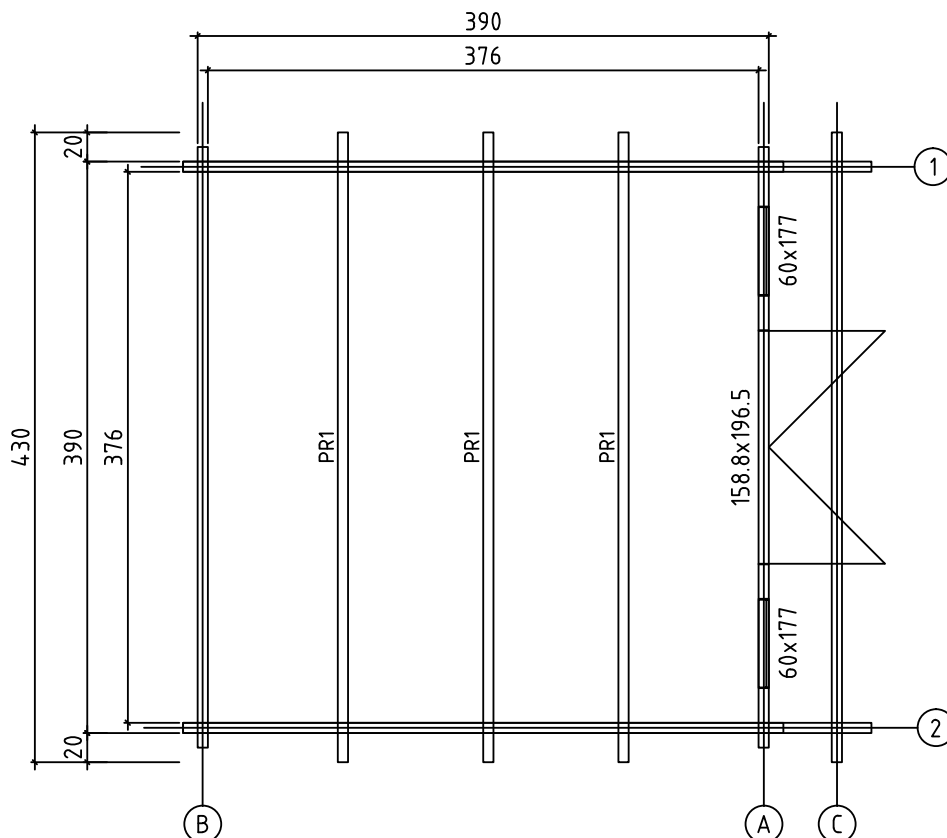
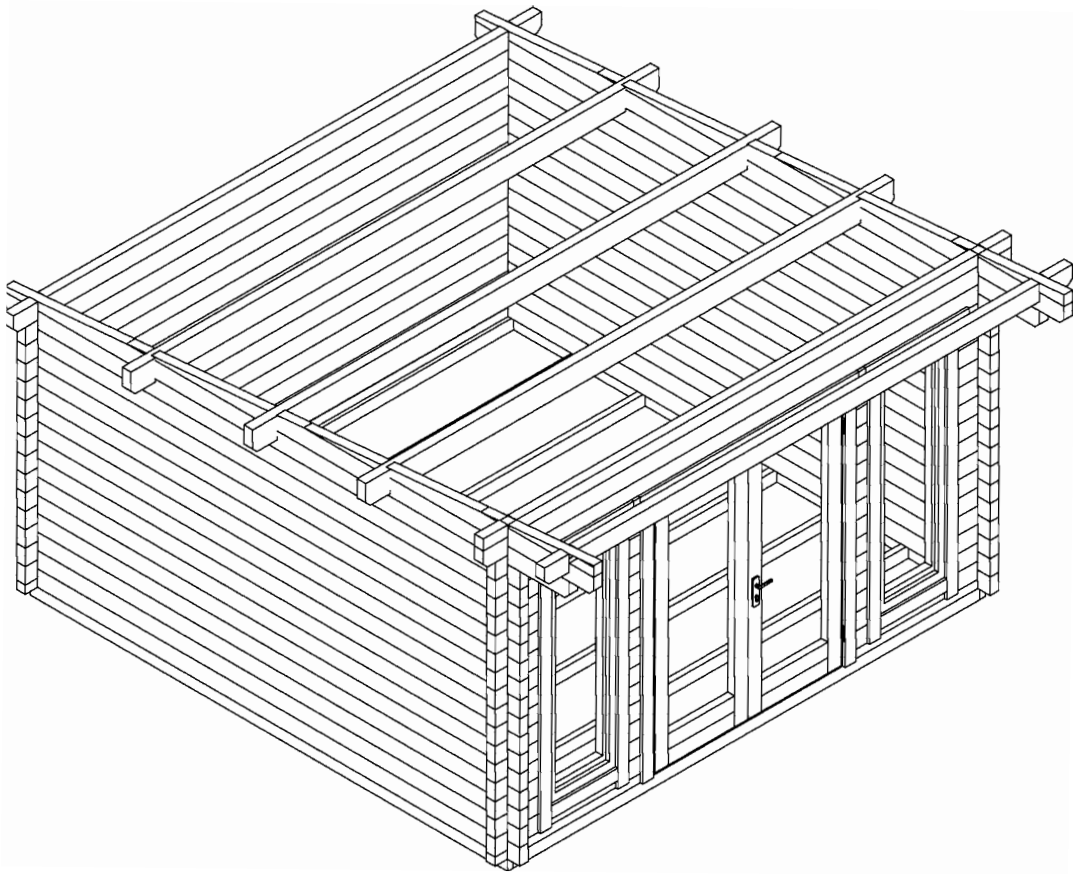





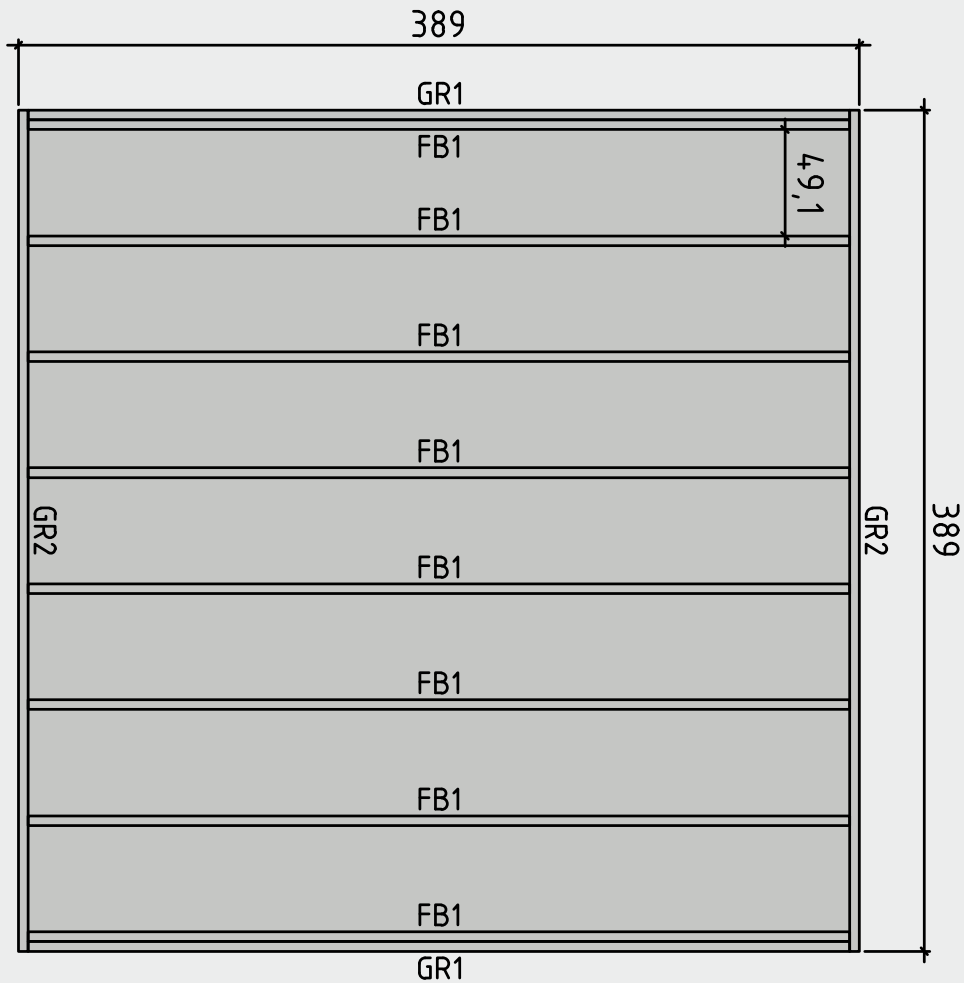

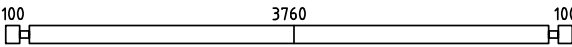
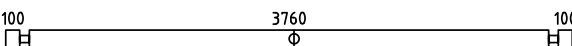
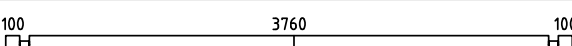
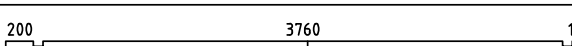
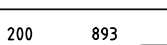
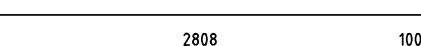

Lagerholzplan und Fundamentplan 870825

Wir empfehlen als Fundament für Ihr Gartenhaus eine vollflächig festgegründete, gepflasterte oder betonierte Fläche.
Wahlweise ist auch ein Punkt- oder Streifenfundament möglich.

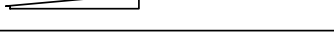

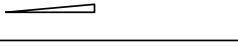
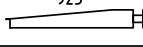

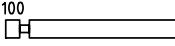
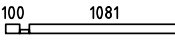

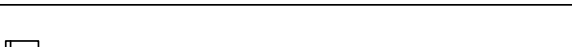
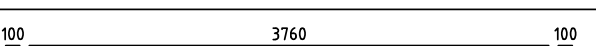
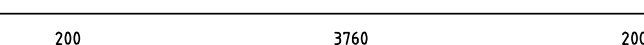
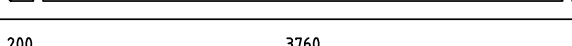
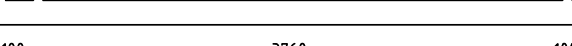
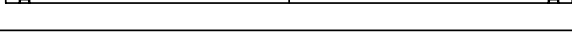
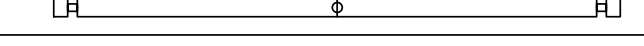
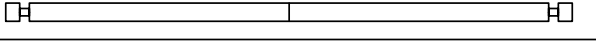

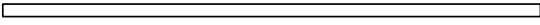
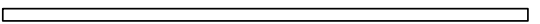
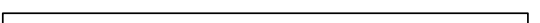
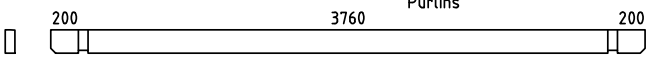
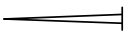

Teileliste 1

870825

Pos			Profil (mm)	Lenght (mm)
001		2	70x130	4100
002		1	70x130	4100
003		24	70x130	4100
004		2	70x130	4200
005		2	70x130	1163
006		2	70x130	2978
007		2	70x15	171
008		2	70x105	963
009		2	70x130	2385
010		2	70x58	642
011		2	70x130	1693
012		2	70x83	922
013		1	70x130	4100
014		2	70x65	1251
015		2	70x130	1251
016		28	70x130	406
017		28	70x130	235
018		1	70x130	4100
019		1	70x130	4300
020		1	70x85	4300
021		1	70x65	4100
022		1	70x130	4100
023		13	70x130	4100
024		1	70x130	4300
025		1	70x130	4300

Teileliste 2

870825

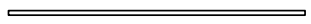
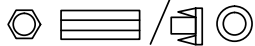
Pos			Profil (mm)	Lenght (mm)
GR2	GROUNDFRAME 	2	45x90	3890
GR1	GROUNDFRAME 	2	45x90	3800
FB1	FLOORBEAMS 	8	45x90	3800
PR1	Purlins 	3	70x170	4300
	WINDOW 600x1770	2		
	DOOR 1588x1965	1		
1	Screws/Schrauben/Vis 5x100 mm- For fixing first row of wall logs /Fixierung des ersten Bohlenkranzes/Pour fixer les lamesde plancher 	6		
2	Nails/Nägel/Clous 2.5x50 - For fixing floorboards/ Befestigung Fussbodenbretter/Pour fixer les lames de plancher 	350		
3	Nails/Nägel/Clous 2.5x50 - For fixing roofboards/ Befestigung Dachbretter/Pour fixer les voliges 	300		
4	Nails/Nägel/Clous 2.5x50 - For fixing floor edge trims/ Befestigung Fussleisten/Pour fixer les plinthes du plancher 	30		
5	Nails/Nägel/Clous 2.5x50 - For fixing roofing felt fillet/ Befestigung giebelabschlussbrett/Pour fixer la latte de finition de la couverture 	30		
6	Screws/Schrauben/Vis 2,5x50 mm- For fixing roof side boards and roof edge reinforcement Befestigung Traufenbretter und Traufenleisten Pour fixer les planches de rive et le tasseau de refront 	150		
7	Screws/Schrauben/Vis 2,5x50 mm- For fixing fascia boards and diamonds/ Befestigung Giebelblende und Raute Pour fixer les planches de rive et le diamant 			
8	Screws/Schrauben/Vis 2,5x50 mm- For fixing fwindow and door trims/ Befestigung Fenster und türen/ Pour fixer les croisillons des fenetres et des portes 			
9	Metal storm Brace/Gewindestange/Tige filetee 10 mm 	3		
10	Shim,Nuts/Mutter ,U-Scheibe/Ecrou,Rondelle 10 mm For fixing storm braces/ Pour fixer les anti tempeete/ Für Sturmleisten Pour fixer les croisillons des fenetres et des portes  Metal storm Brace/Gewindestange/Tige filetee 10 mm KL1 M10 2,18 m 2 Screws 180 6 pcs. KL2 M10 2,12 m 1 Plastic caps 3 pcs.	3/3		

Teileliste 3

870825

POS	ST.	B	H	L	Teileliste
FB1	Vt. spetsi				FUNDMENTHOLZER
F1	14,13m ²	28		3755	FUSSBODENBRETTER
PR	3	70	170	4300	DACHBALKEN
RB1	20,7m ²	20		4819	DACHBRETTER
R1	2	20	140	4340	<small>Vaata ketise kaltepurka</small> Traufenbretter
R2	2	45	65	4300	<small>Vaata ketise kaltepurka</small> Traufenbretter
R3	2	20	140	5020	<small>Vaata ketise kaltepurka</small> Giebelabschlussleiste
R4	2	20	90	5020	Giebelabschlussleiste
WN06	2	600	1770		<p style="text-align: center;">Sliding slats 30x30x1700 mm - 4 pcs.</p>
DR16	1	1588	1965		
P1	16m	20	40		Fußbodenleiste
P2	6+6	20	90	1945	Türleiste DR 16, Fensterleiste WN 06
P3	1+1	20	90	3600	Türleiste DR 16, Fensterleiste WN 06
P4	2+2	20	90	540 570	Fensterleiste WN 06

Detailzeichnungen 870825

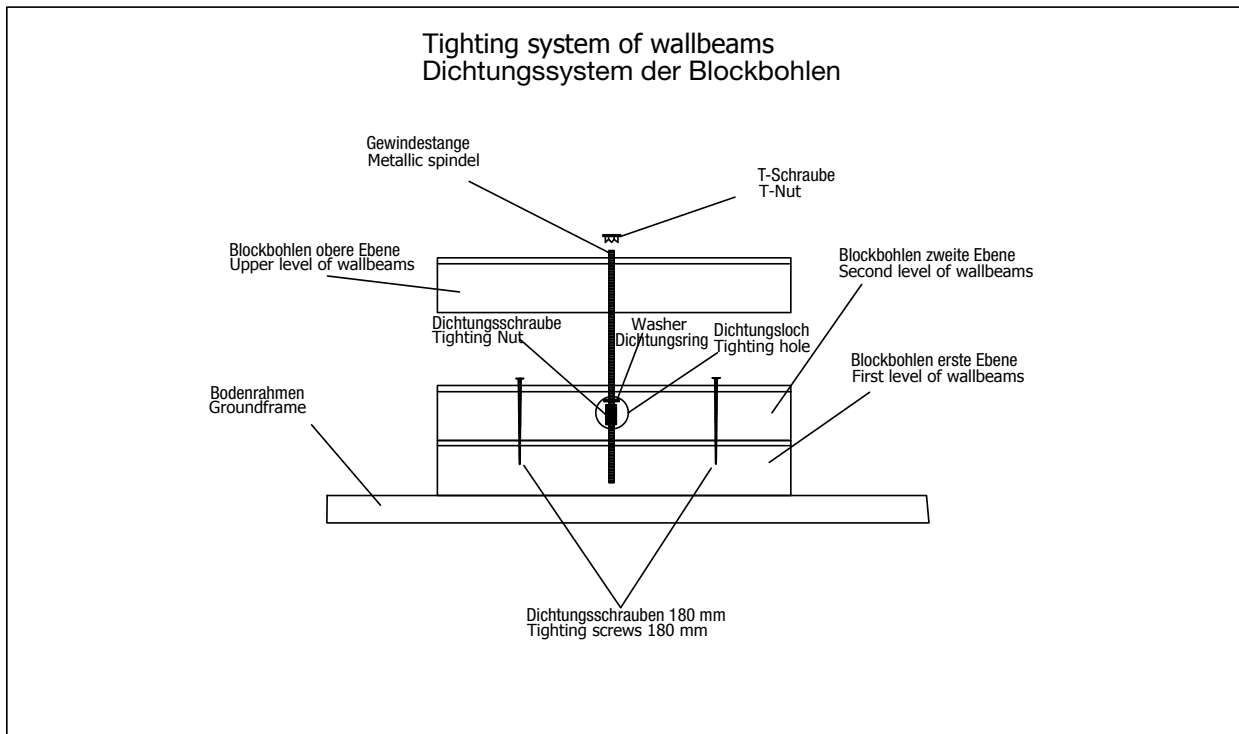
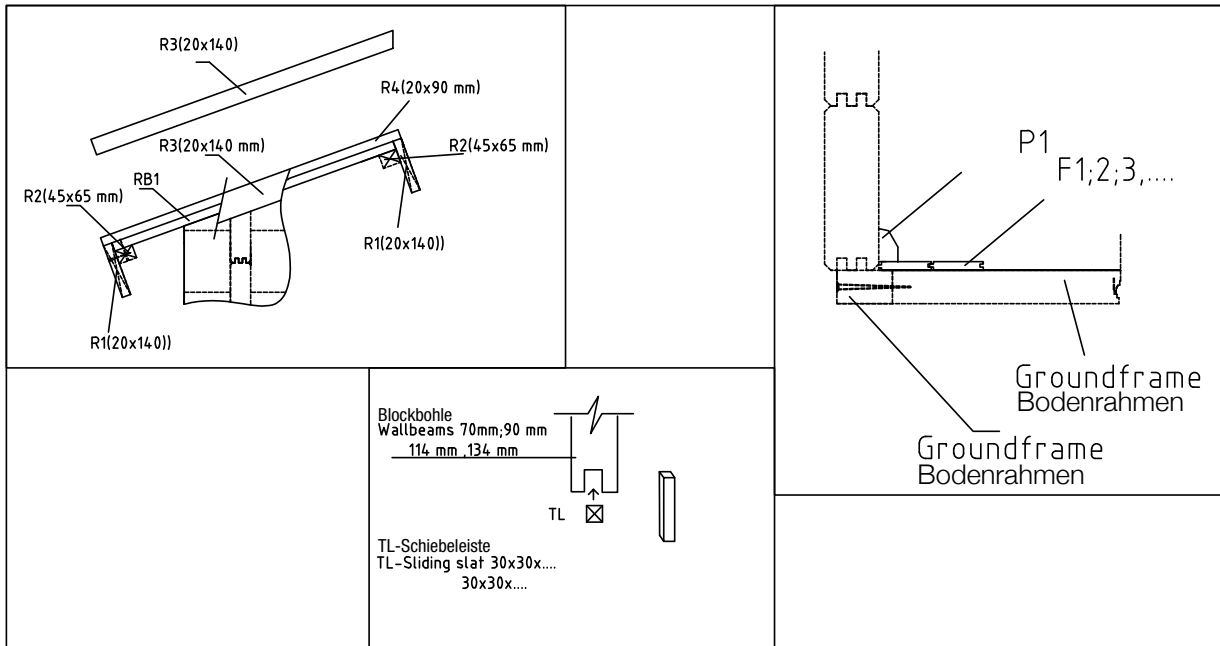

Wandplan 1 und 2 870825

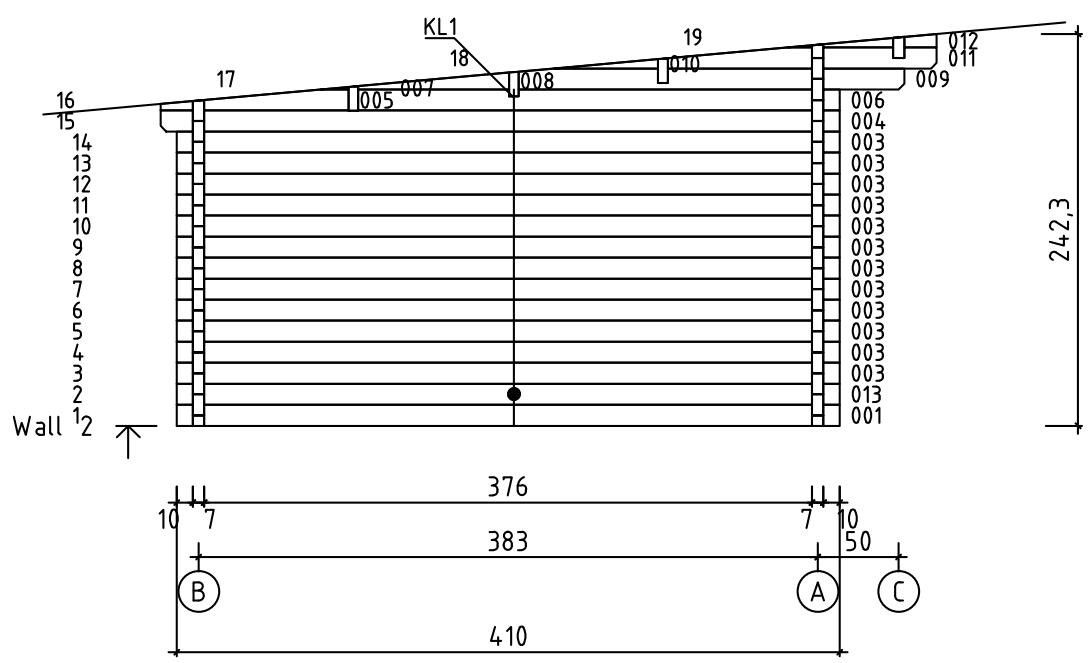
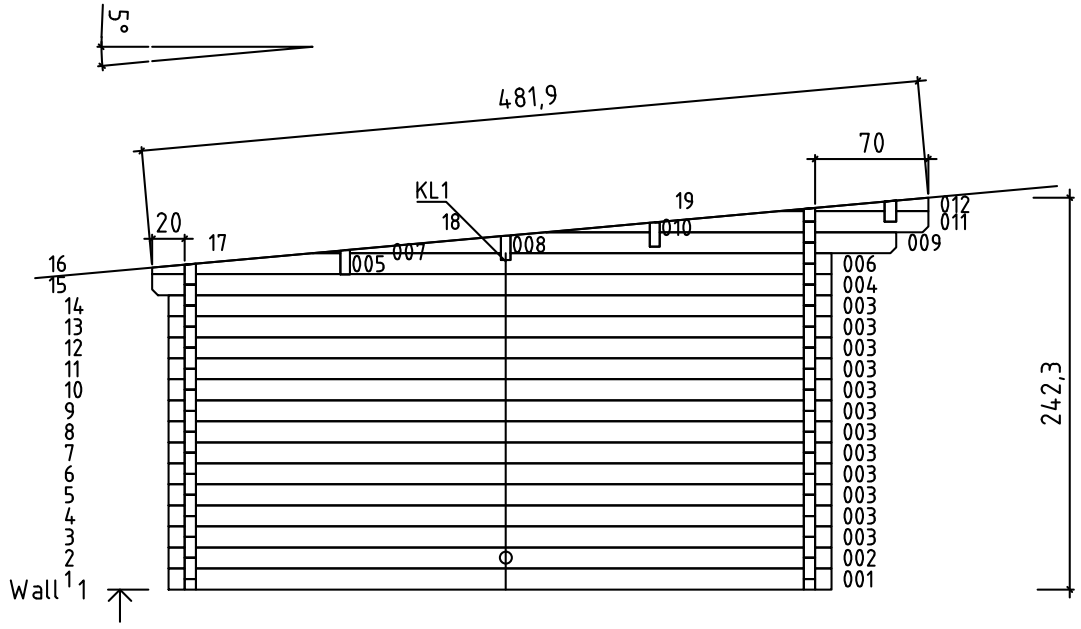

Wandplan A und B 870825

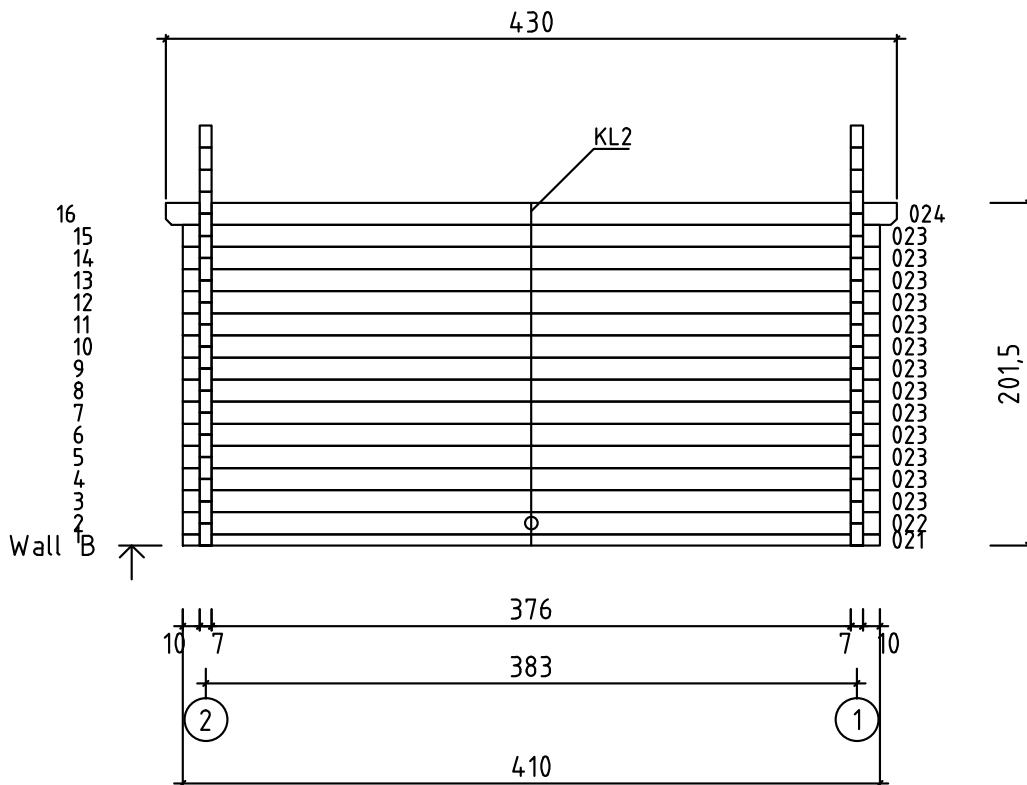
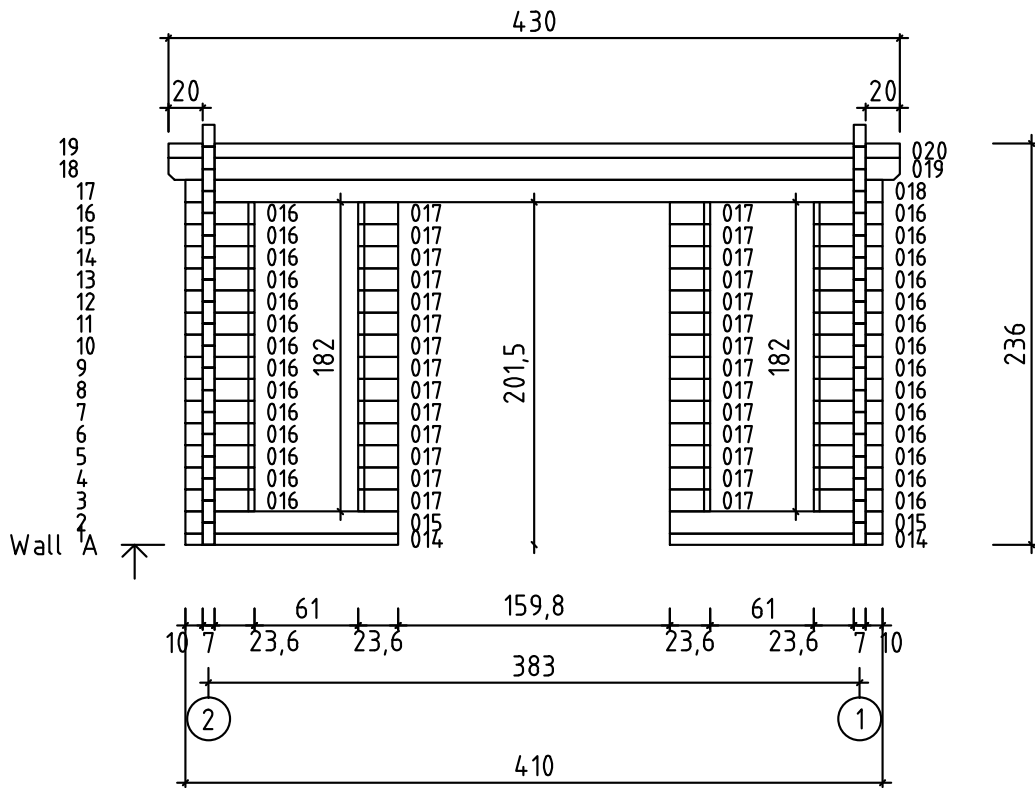

Wandplan C 870825

Vorgelagerte Vordachbohle vor Wand A

