

## Technische Daten: Art.-Nr.: 350 140

Wandaußenmaß: 396 x 210 cm

Bohlenstärke: 70 mm



Kontrolliert durch:

Achtung: Alle angegebenen Maße sind ca.-Maße!

# 3D-Darstellung Art.-Nr. 350 140

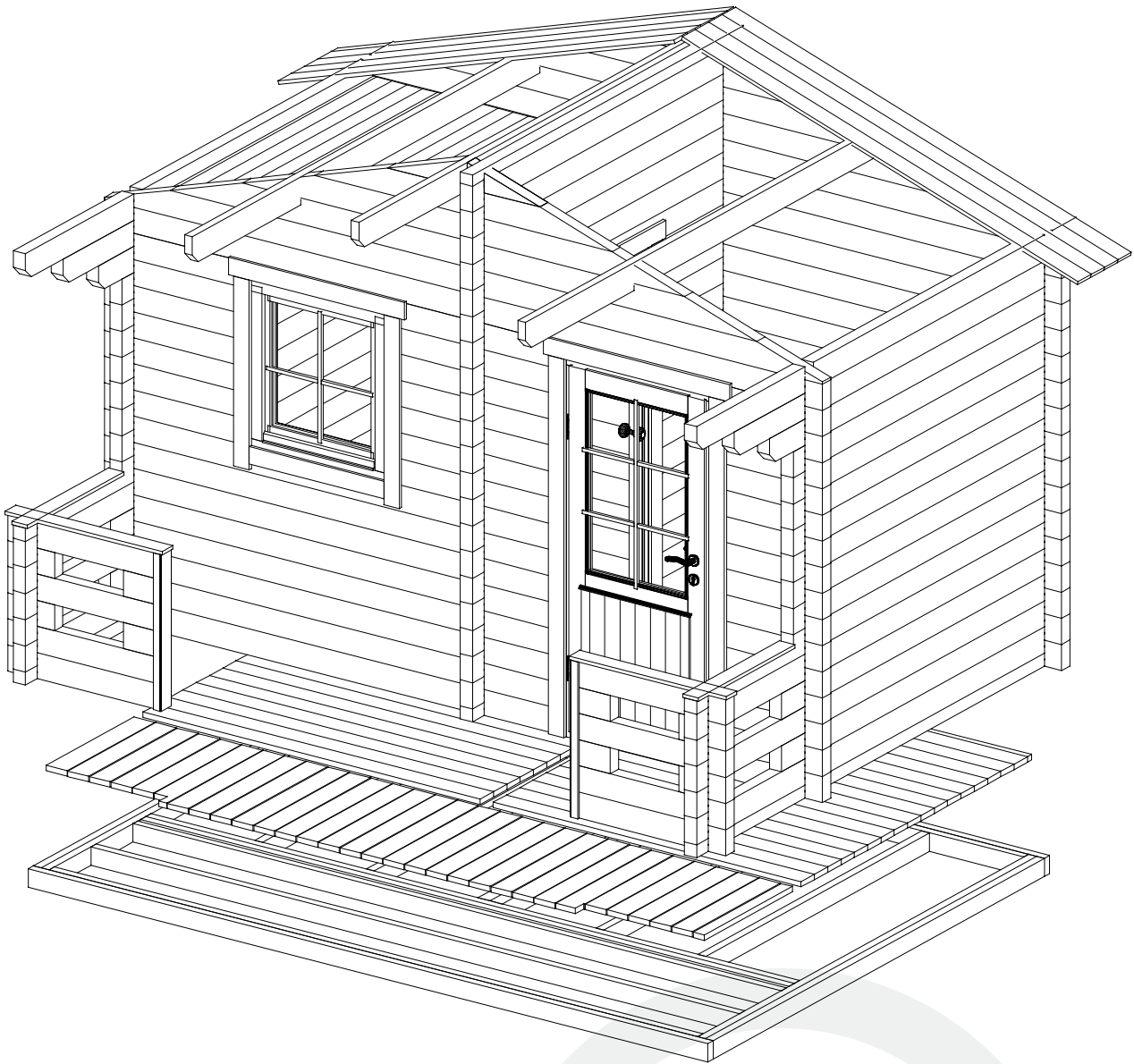

# Grundriss

## Art.-Nr. 350 140

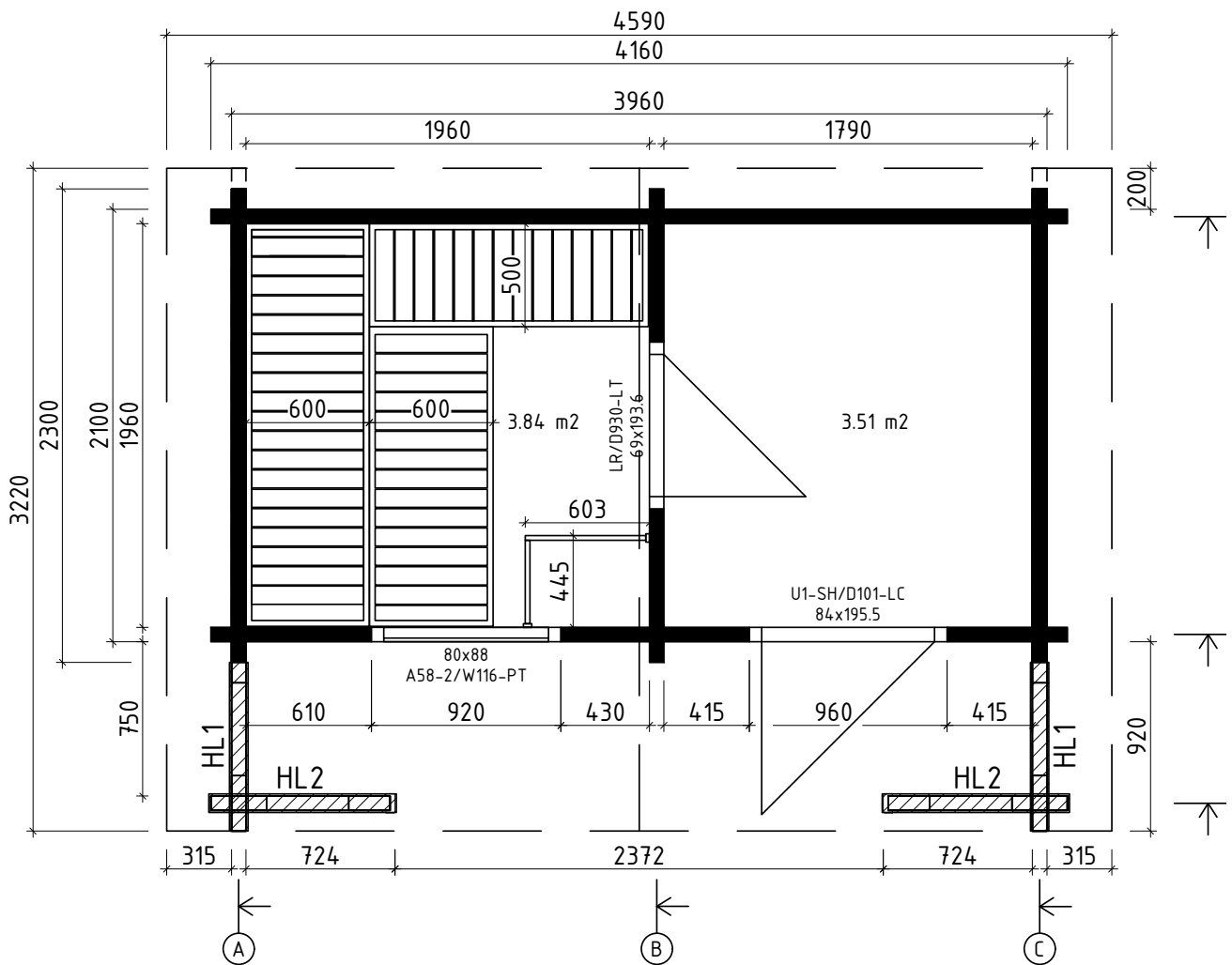

**Q4** – Qualitätsklasse für Fenster und Türen  
 \*Fenster und Türen sind mit Sprossen

# Lagerholzplan und Fundamentplan Art.-Nr. 350 140

Wir empfehlen als Fundament für Ihr Gartenhaus eine vollflächig festgegründete, gepflasterte oder betonierte Fläche.  
Wahlweise ist auch ein Punkt- oder Streifenfundament möglich.

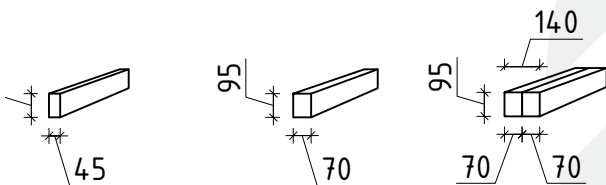
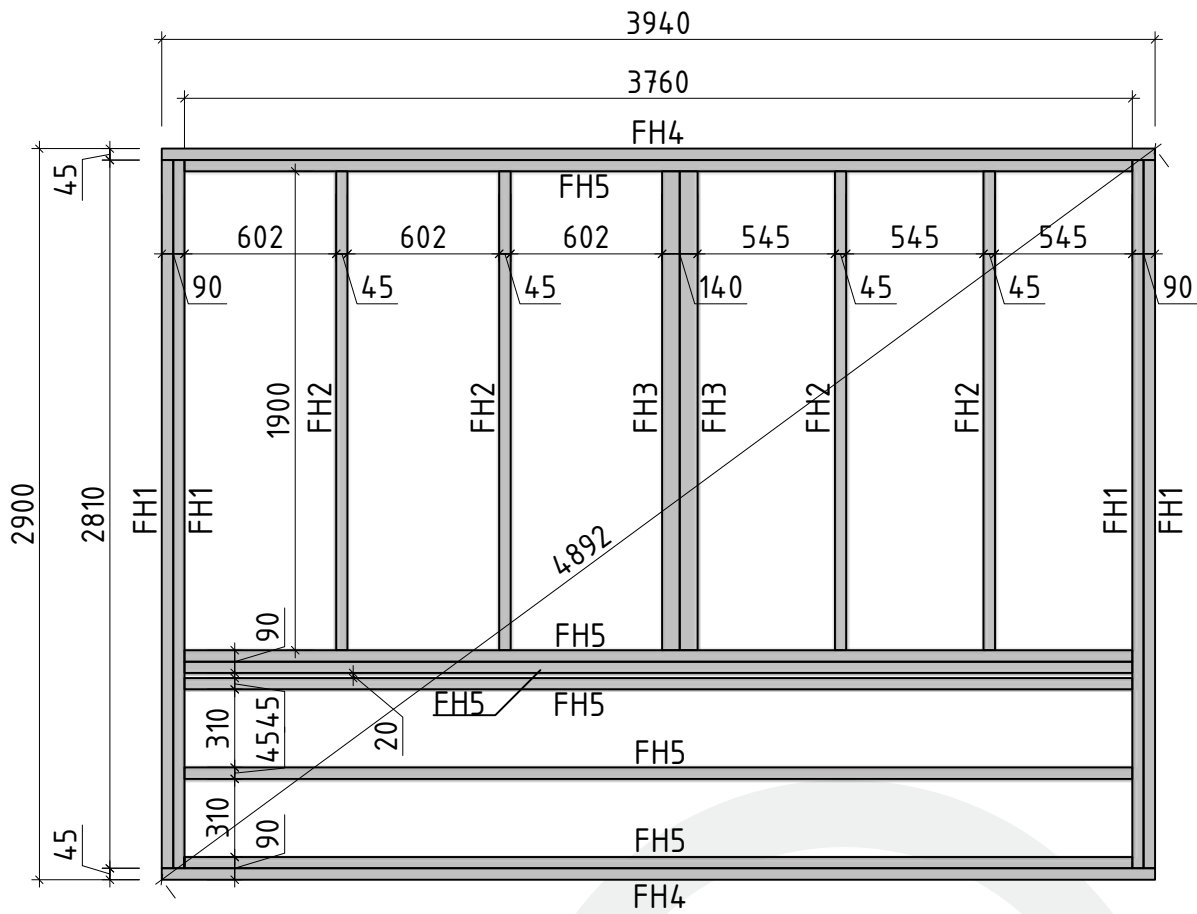

# Teileliste 1

## Art.-Nr. 350 140

Pos		Stck.	Profil (mm)	Länge (mm)
	<b>Achtung!</b> Die Giebelbohlen können teilweise schon vormontiert sein! Bitte beachten - diese erscheinen nicht ganz so wie in der Teileliste beschrieben.			
001		2	70x135	4160
002		15	70x135	4160
003		2	70x135	4160
004		2	70x135	3400
005		1	70x135	3220
006		1	70x135	3220
007		2	70x68	3120
008		4	70x135	3120
009		2	70x135	3120
010		2	70x135	3120
011		2	70x135	2800
012		6	70x135	2615
013		1	70x135	2615
014		1	70x135	2615
015		2	70x135	2561
016		2	70x135	2500
017		4	70x135	2400
018		19	70x135	2300
019		1	70x58	2300
020		1	70x135	2300
021		2	70x135	1722
022		7	70x135	915
023		4	70x135	870
024		2	70x135	870













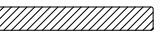

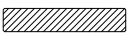

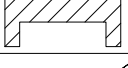

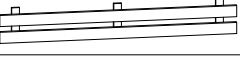

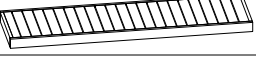
# Teileliste 2

## Artikel-Nr.: 350 140

Pos		Stck	Profil (mm)	Länge (mm)
025		2	70x135	870
026		7	70x135	780
027		1	70x68	745
028		1	70x68	745
029		15	70x135	745
030		13	70x135	745
031		15	70x135	585
032		2	70x135	420
033		2	70x135	420
034		8	70x135	270
035		4	70x135	200
FH3	FUNDAMENTHÖLZER (imprägniert) 	2	70x95	1900
FH4	FUNDAMENTHÖLZER (imprägniert) 	2	45x95	3940
FH5	FUNDAMENTHÖLZER (imprägniert) 	6	45x95	3760
FH1	FUNDAMENTHÖLZER (imprägniert) 	4	45x95	2810
FH2	FUNDAMENTHÖLZER (imprägniert) 	4	45x95	1900
HL2	HANDLAUF 	2	95x18	910
HL1	HANDLAUF 	2	95x18	820
HS1	HOLZSCHWELLE 	1	75x28	750
PF1	PFETTEN <sub>200</sub> 	3	44x145	3220
	DACHBRETT 	58+1	113x18	2410
	FUSSBODENBRETT 	18+1	113x28	1955
	FUSSBODENBRETT 	18	113x28	1785
	TERRASSENBRETT 	20+1	120x28	815
	TERRASSENBRETT 	11	120x28	745





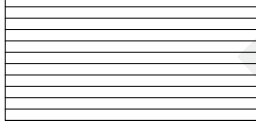

















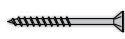

# Teileliste 3

## Artikel-Nr.: 350 140

Pos		Stck	Profil (mm)	Länge (mm)
	DECKENLEISTEN 	✓	15x28	23.0lfm
	FUSSBODENLEISTEN 	✓	14x55	17.0lfm
G02-1	GIEBELBRETTER 18x120  17,8°	✓	4 18x120	2490
G06-1	GIEBELDECKLEISTEN 18x58  17,8°	✓	4 18x58	2490
T01-1	TRAUFBRETTER 18x95 		2 18x95	3220
T06-1	TRAUFENLEISTEN 18x40 	✓	18x40	7.0lfm
UP6-1	U-PROFIL 70 	✓	2 44x94	810
GS	Giebelsegment 	2		
SA16-1	SAUNA - Bänke Zwischenstück 	1	40x300	1955
SA15-1	SAUNA - Rücklehne 	2	40x250	1860
SA02-1	SAUNA - Saunabank 50cm 	1	500x90	1355
SA01-1	SAUNA - Saunabank 60cm 	2	600x90	1955
SA11-1	SAUNA - Stützpfeiler für Saunabänke 	✓	1 44x65	500
SA11-2	SAUNA - Stützpfeiler für Saunabänke 	✓	2 44x65	1000
SA20-1	SAUNA - Trägleiste für Deckenisolation 	✓	4 35x35	2000
SA10-1	SAUNA - Trägleiste für Saunabänke 	✓	3 30x40	600
SA10-2	SAUNA - Trägleiste für Saunabänke 	✓	2 30x40	1200
SA30	SAUNA - Heizung Umbau (set 1) 	1		
SA35	SAUNA - Kopfstütze 	2		
SA37	SAUNA - Bodenrost 	1		
SA36	SAUNA - Luftschieber 	3		
SA25-1	SAUNA - Dichtungsband für Deckenisolationselemente 	✓	1	8.0lfm
SLK	DECKENISOLATION 		2 Elemente	ca 1950x975

# Teileliste 4

## Artikel-Nr.: 350 140

Pos			Stck	Profil (mm)	Länge (mm)
SH	Schlaghölzer		3		
TL70-1	T-LEISTE 70		2	45x70	895
TL70-2	T-LEISTE 70		2	45x70	1908
TL70-3	T-LEISTE 70		2	45x70	1975
KL1	Gewindestange M8		4		2000
KL2	Gewindestange M8		2		810
KL3	Gewindestange M8		4		325
KV M UT M8	Mutter M8		12		
KV S EIB M8X25	U-Scheibe M8 Ø25		12		
KV MU TJ M8	Befestigungsmutter M8		4		
LMT01	Schlagmutter M8		2		
SS023	Schloßschrauben M8x70 Mutter M8 U-Scheibe Ø25 - Befestigung für Saunabänke		2		
NG04	NÄGEL 2.5x50 Dachbretter		348		
SR32	SCHRAUBEN 3.0x30 Bänke Zwischenstück, Luftschieber		24		
SR3030	SCHRAUBEN 3.0x30 Deckenleisten		50		
SR3030	SCHRAUBEN 3.0x30 Fussbodenleisten		35		
SR37	SCHRAUBEN 3.5x45 Heizung Umbau		8		
SR3547	SCHRAUBEN 3.5x45 C3 Handlauf		12		
SR3547	SCHRAUBEN 3.5x45 C3 Fenster- und Türleisten		68		
SR3547	SCHRAUBEN 3.5x45 C3 Giebelbretter		20		
SR3547	SCHRAUBEN 3.5x45 C3 Giebeldeckleisten		20		
SR3547	SCHRAUBEN 3.5x45 C3 Giebelsegment		4		
SR3547	SCHRAUBEN 3.5x45 C3 Traufenbretter		15		
SR3547	SCHRAUBEN 3.5x45 C3 Traufenleisten		15		
SR3547	SCHRAUBEN 3.5x45 C3 U-Profil		6		



# Teileliste 5

## Artikel-Nr.: 350 140

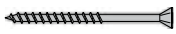
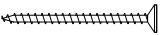
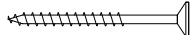
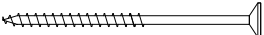
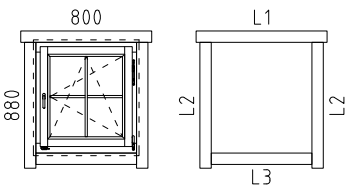
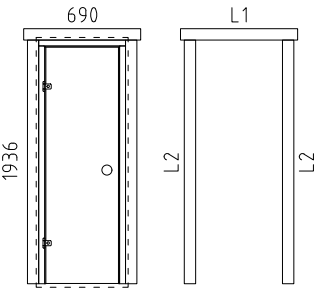
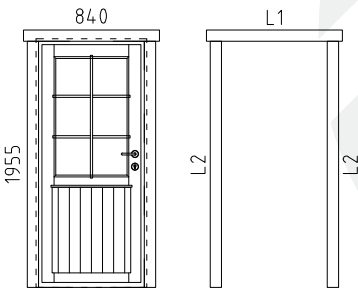
Pos		Stck.	Profil (mm)	Länge (mm)
SR4 257	SCHRAUBEN 4.2x55 C2 28mm Fussbodenbretter		144	
SR4 267	SCHRAUBEN 4.2x65 C3 28mm Terrassenbretter		186	
SR44	SCHRAUBEN 4.0x60 Trägleiste für Saunabänke, Rücklehne Trägleiste für Deckenisolation		62	
SR55	SCHRAUBEN 5.0x70 Stützpfeiler für Saunabänke		10	
SR57	SCHRAUBEN 5.0x100 Fundamenthölzer		72	
Q4 FENSTER	W4-S70P-04T-08000880	1		
	 <p>A58-2/W116-PT</p> <p>L1 18x90 L=1040mm 2x L2 18x90 L=1000mm 4x L3 18x90 L=800mm 2x ✓</p> <p>Gehärtete Glas</p>			
TÜR	D0-L70L-0XT-06901936	1		
	 <p>LR/D930-LT</p> <p>L1 18x90 L=930mm 2x L2 18x90 L=1935mm 4x ✓</p> <p>DIN links</p>			
Q4 TÜR	D4-S70L-56C-08401955	1		
	 <p>U1-SH/D101-LC</p> <p>L1 18x90 L=1080mm 2x L2 18x90 L=1955mm 4x ✓</p> <p>DIN links</p>			
✓ - bitte selber anpassen (falls nötig)!				

# Wandplan 1

## Art.-Nr. 350 140

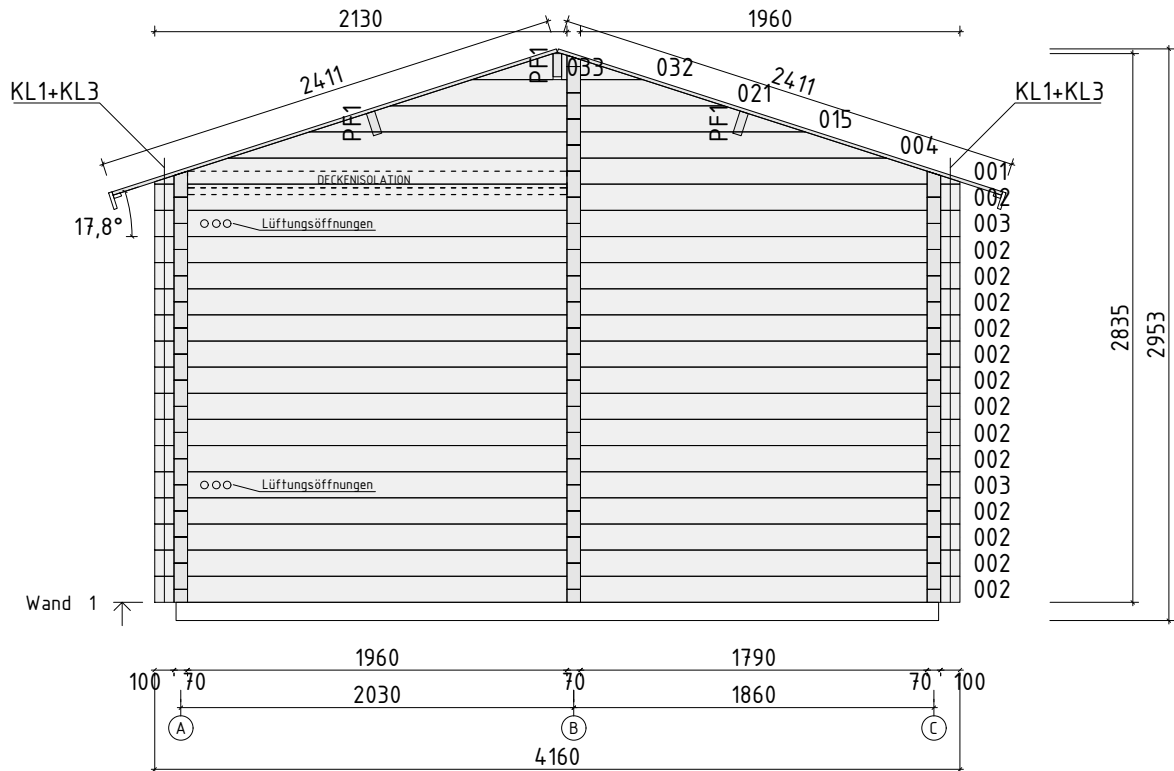
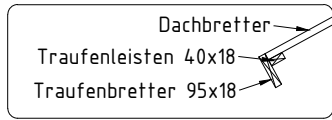

Die Bohlen mit Lüftungsöffnungen können je nach Bedarf höher oder niedriger eingesetzt werden. Bitte achten Sie darauf dass die Lüftungsöffnungen von innen nicht mit der Saunabank bedeckt werden!



# Wandplan 2 Art.-Nr. 350 140

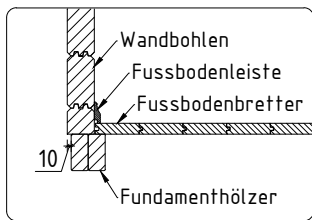
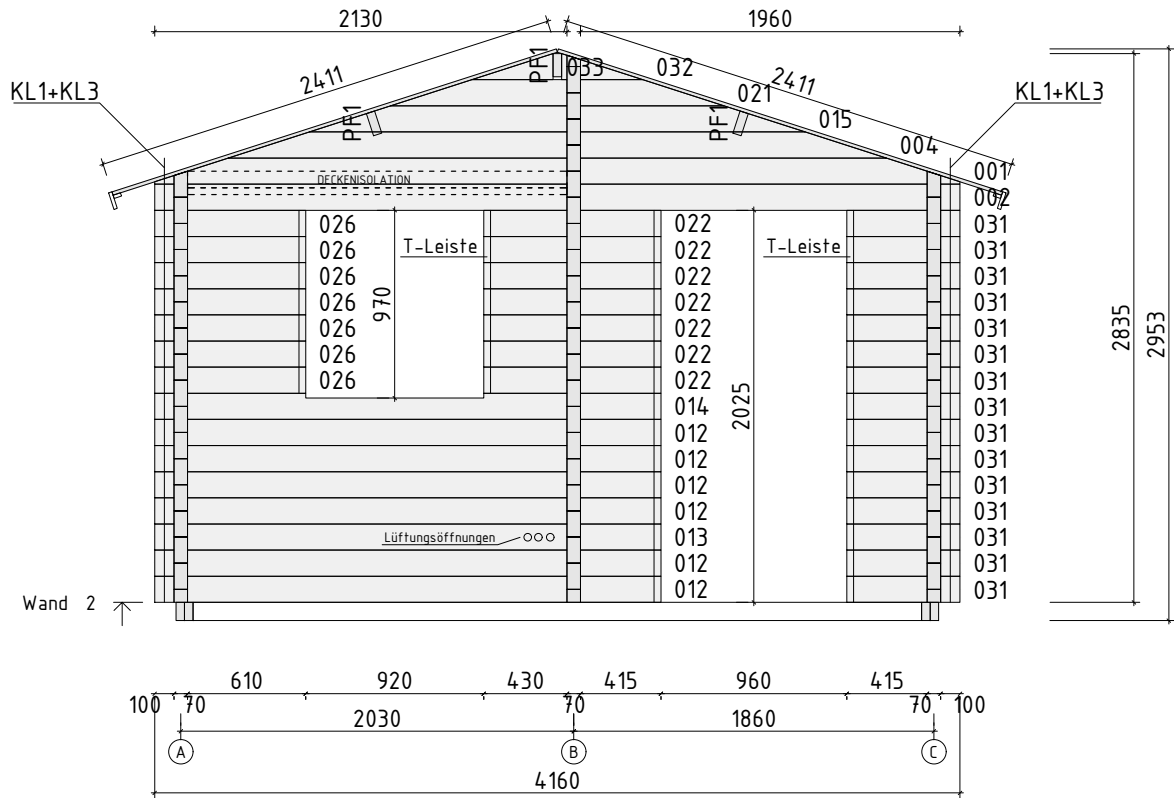

Die Bohlen mit Lüftungsöffnungen können je nach Bedarf höher oder niedriger eingesetzt werden. Bitte achten Sie darauf dass die Lüftungsöffnungen von innen nicht mit der Saunabank bedeckt werden!

# Wandplan 3

## Art.-Nr. 350 140

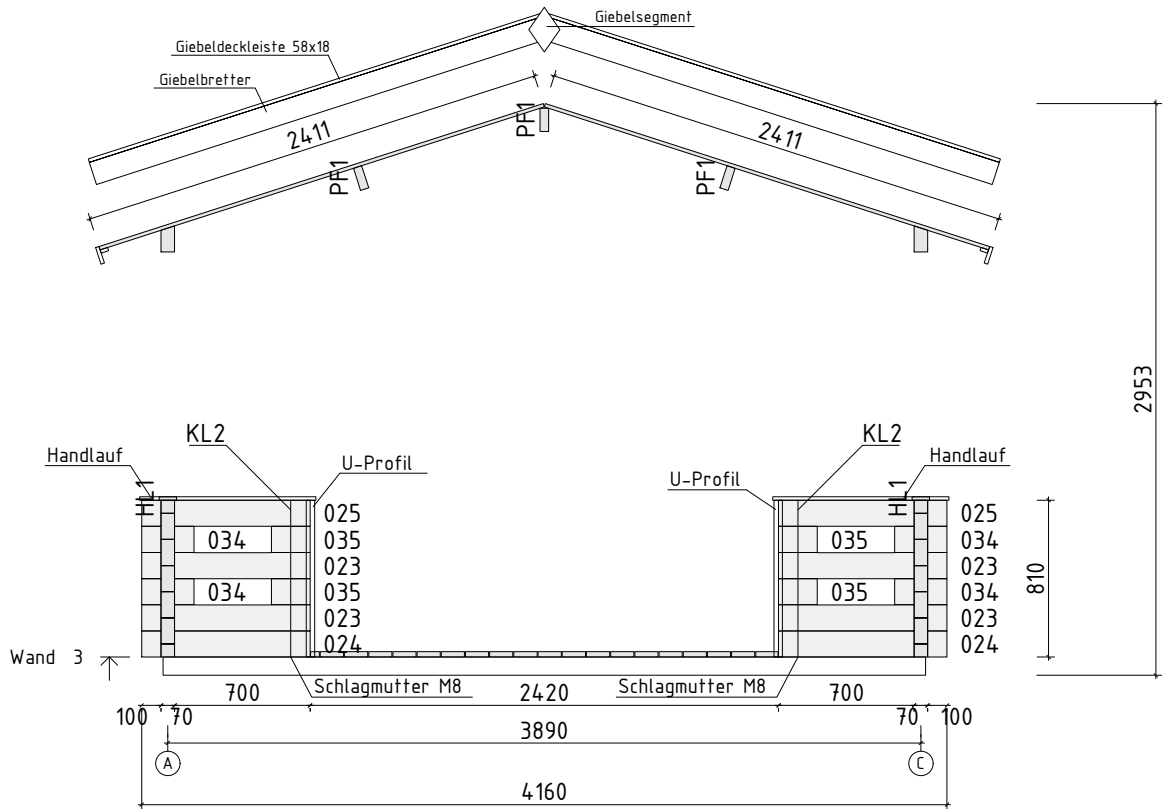

# Wandplan A

## Art.-Nr. 350 140

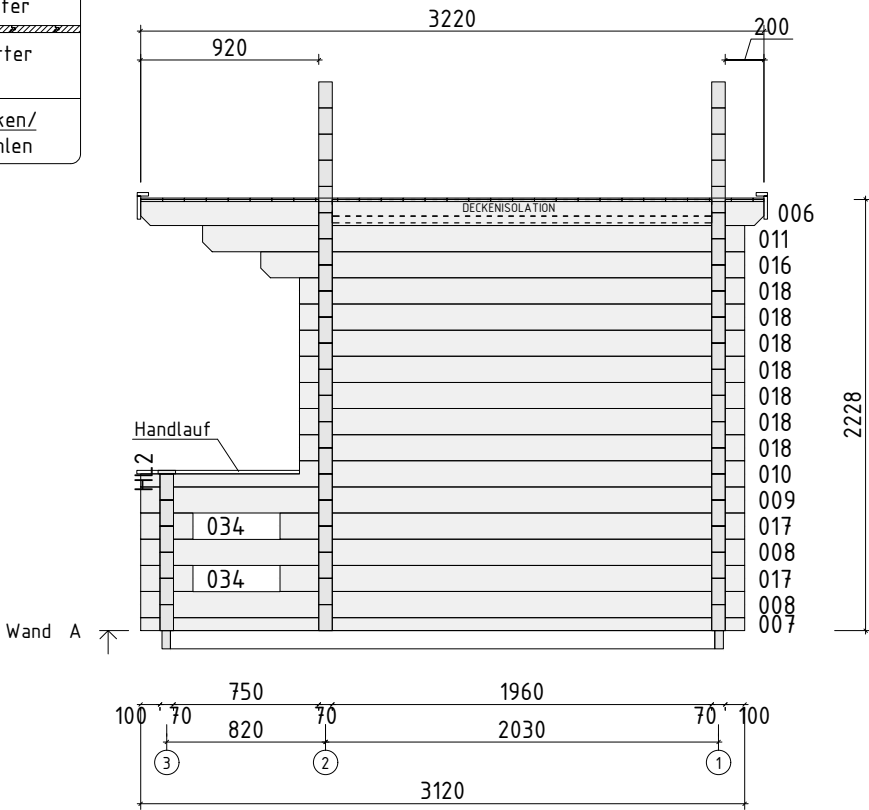
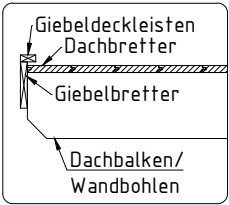

# Wandplan B Art.-Nr. 350 140

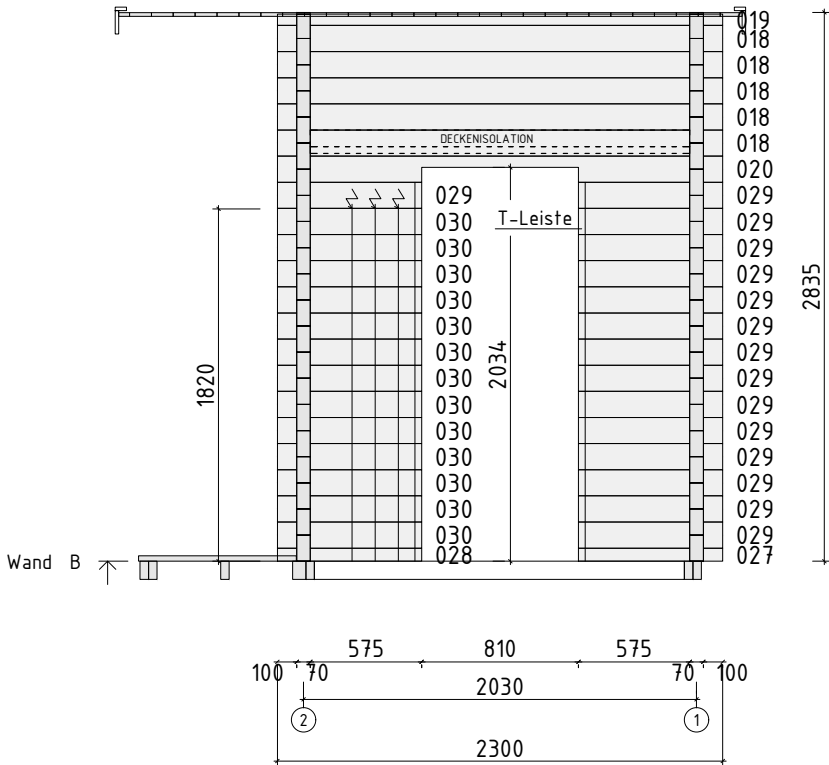

# Wandplan C

## Art.-Nr. 350 140

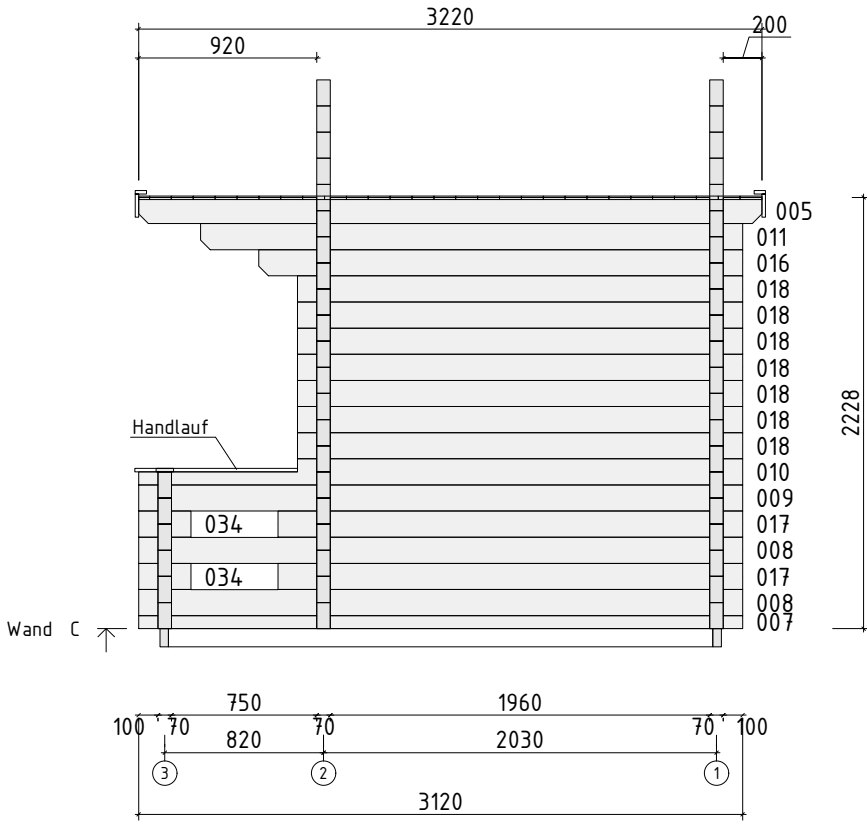

# Montage T-Leisten

## Art.-Nr. 350 140

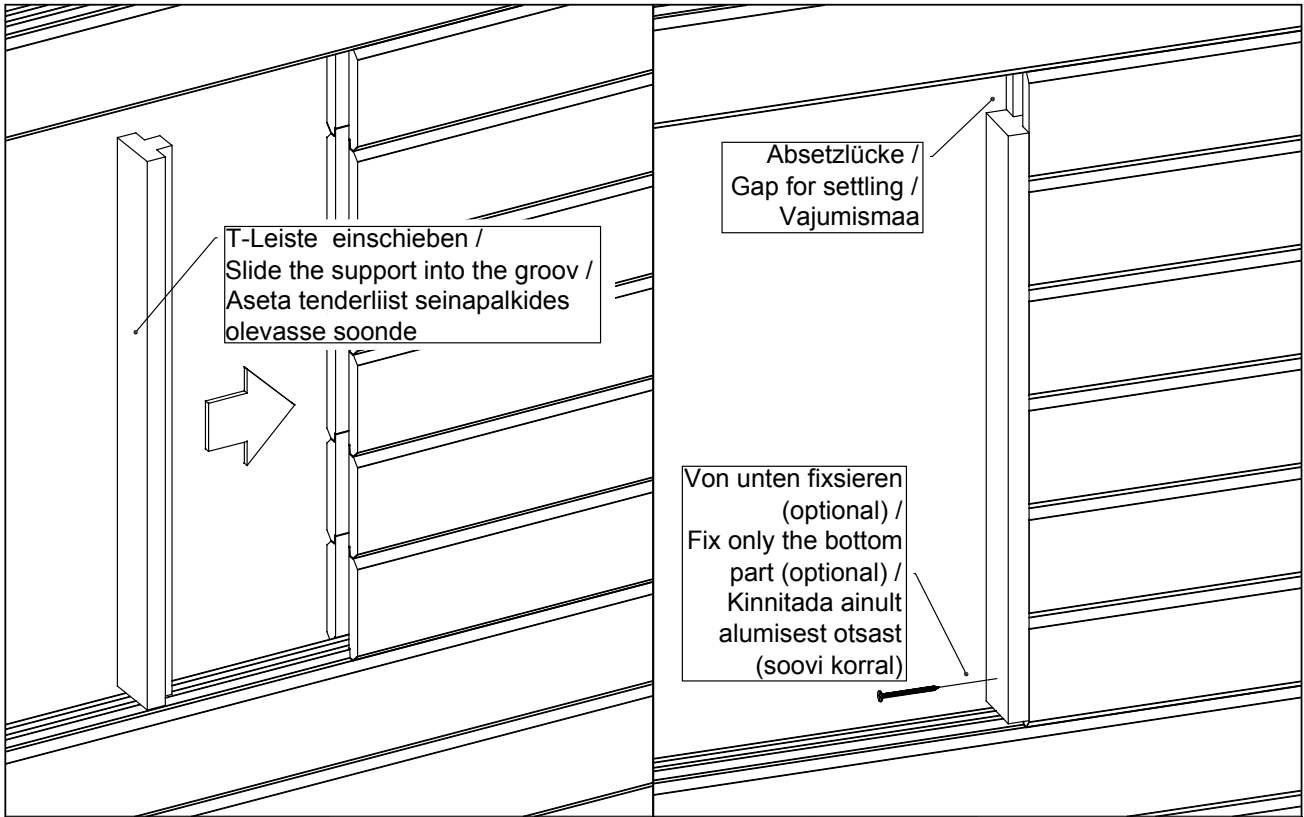



# Fenstermontage

## Art.-Nr. 350 140

Aken Q4-Q6 - paigaldusjuhised  
 Window Q4-Q6 - assembly instructions  
 Fenster Q4-Q6 - Montageanleitung

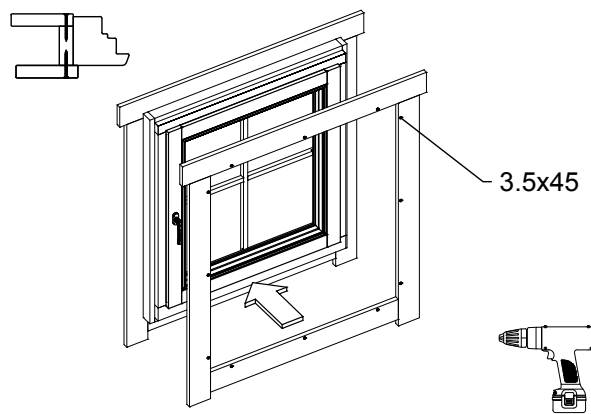
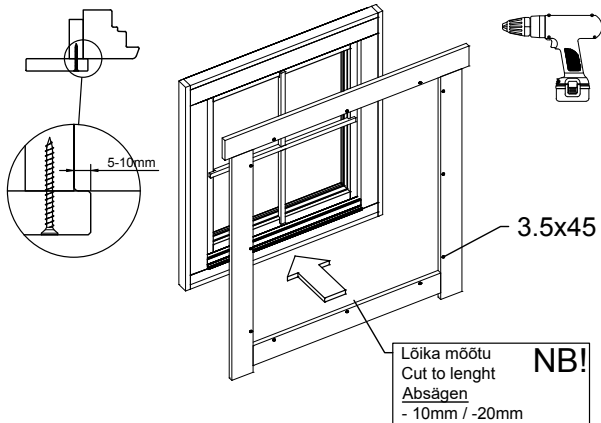
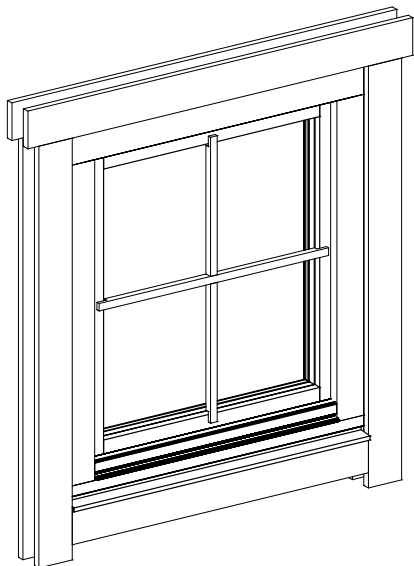

# Fenstermontage

## Art.-Nr. 350 140

### Q4

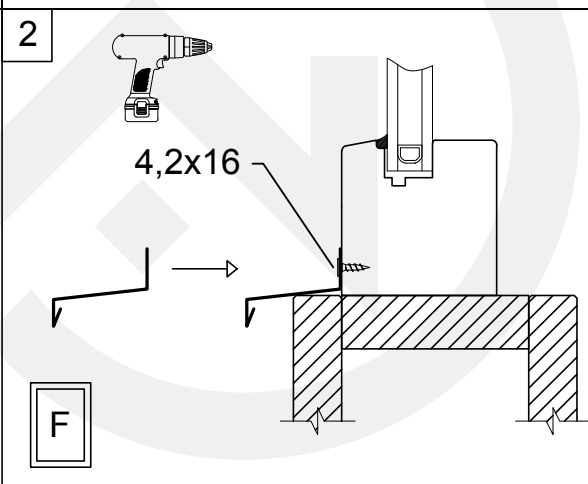
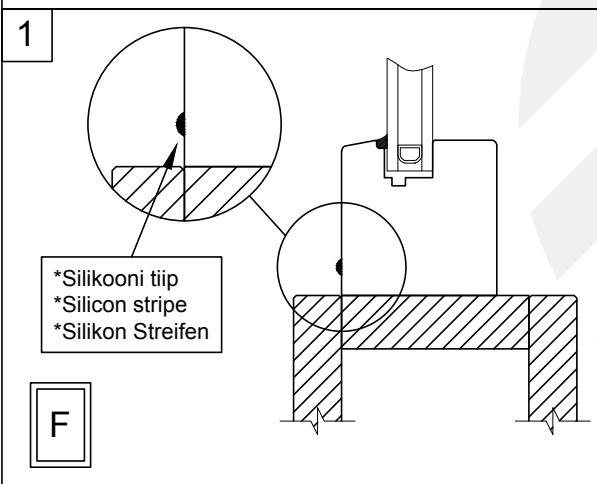
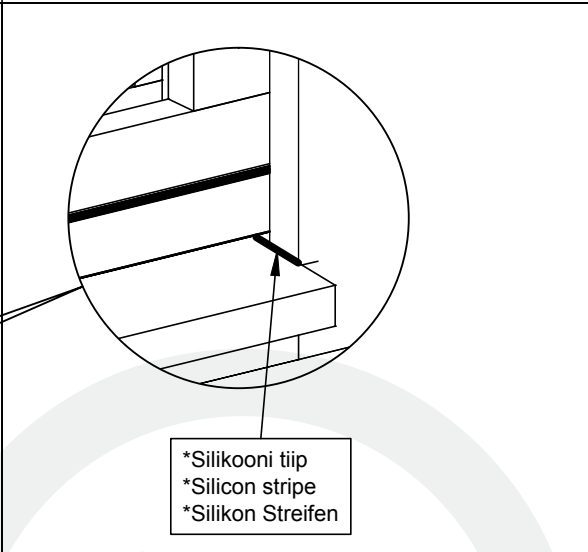
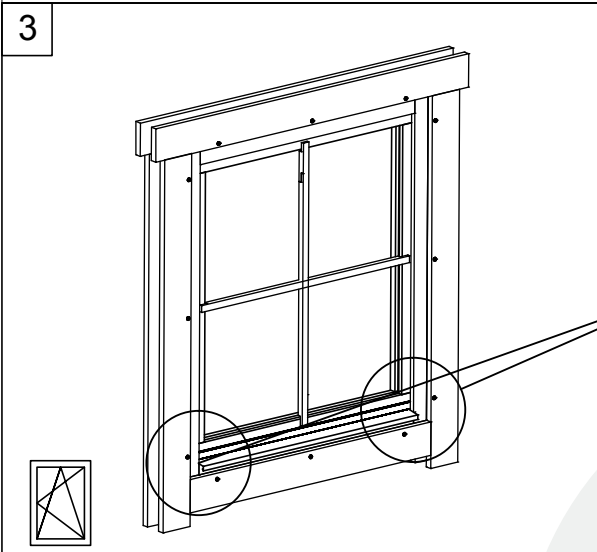
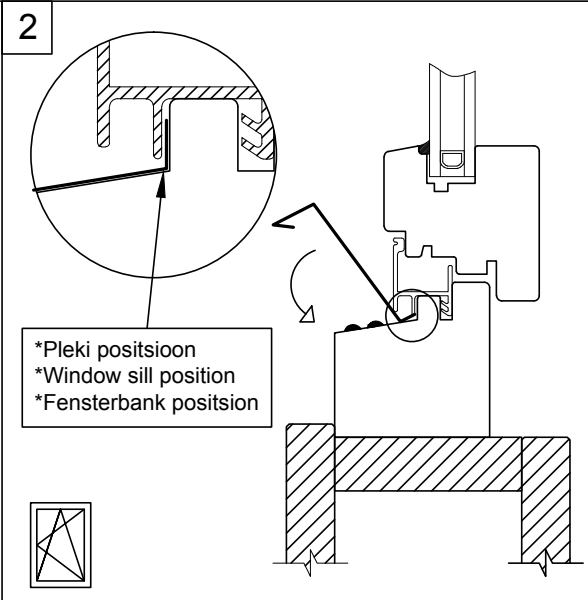
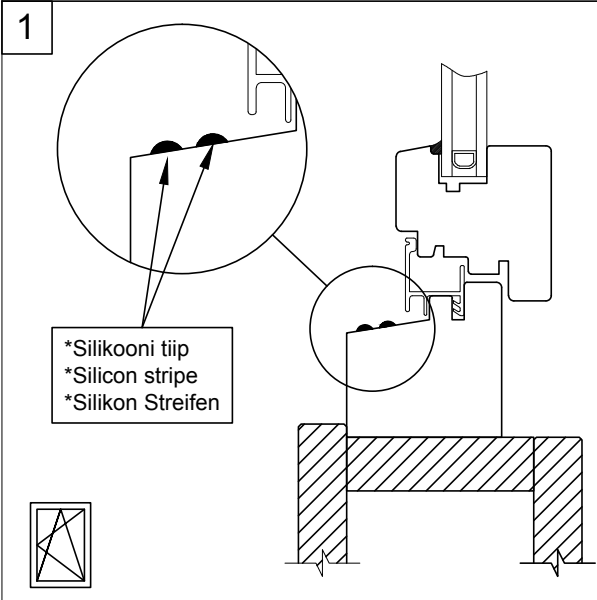

# Türmontage

## Art.-Nr. 350 140

Ukse montaaž / Tür montage / Door assembly  
(GH+ / SH)

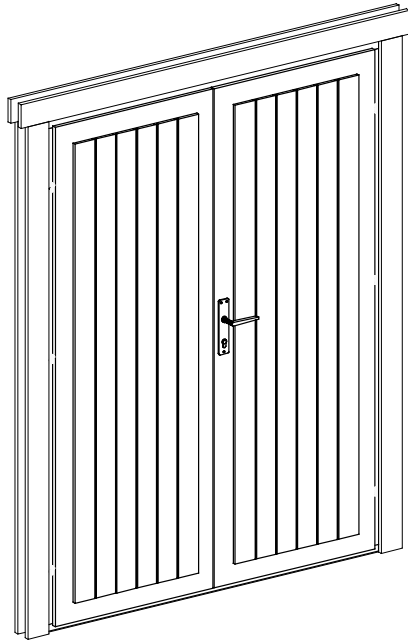

4.5x90

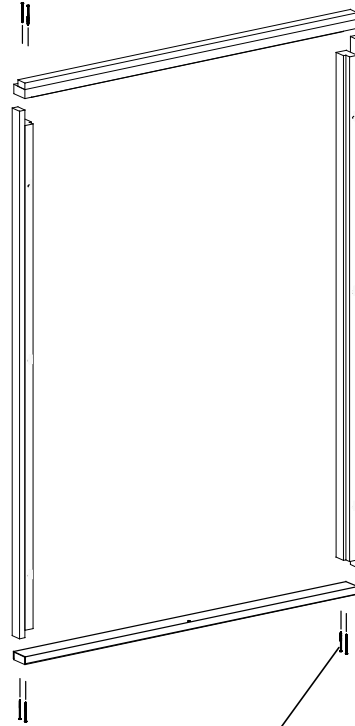

4.5x90



# Türmontage

## Art.-Nr. 350 140

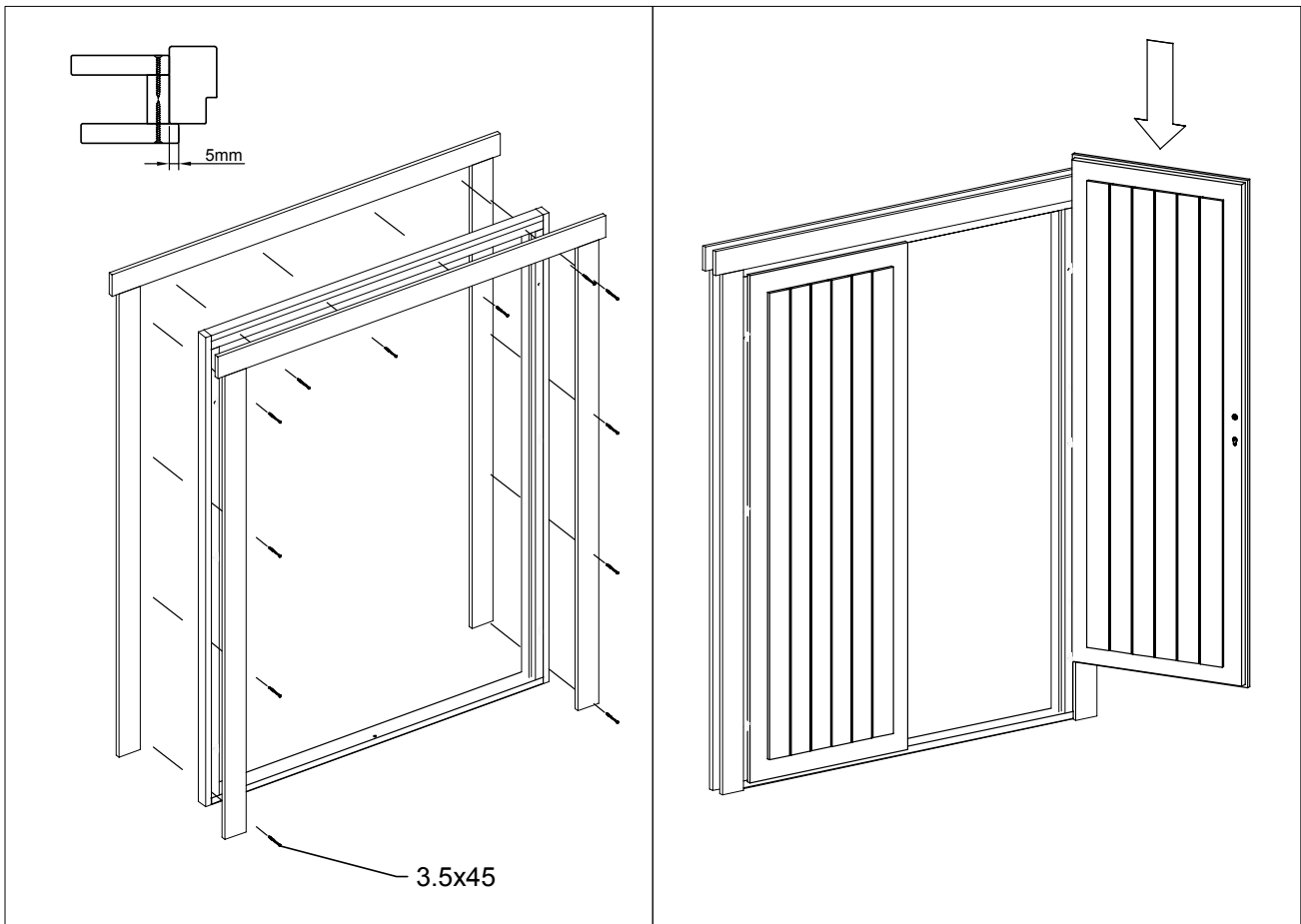

# Türmontage

## Art.-Nr. 350 140

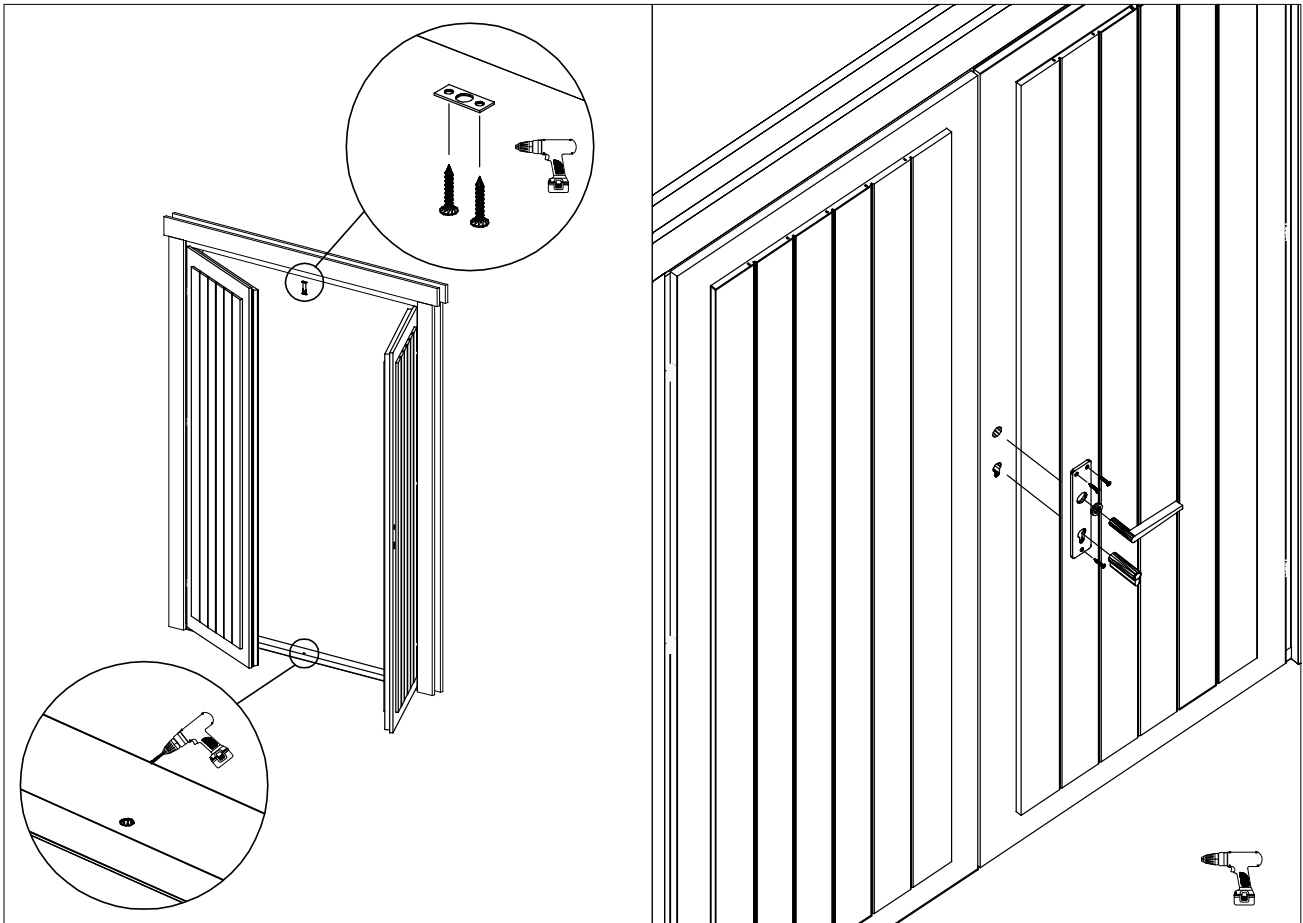

# Türmontage

## Art.-Nr. 350 140

1

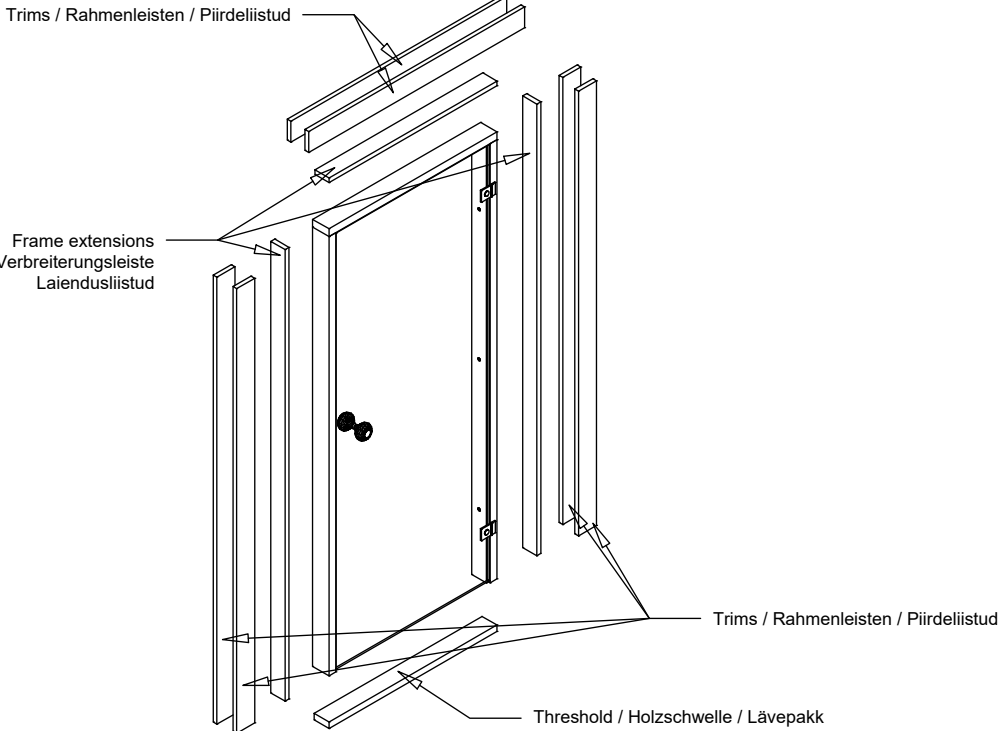

2

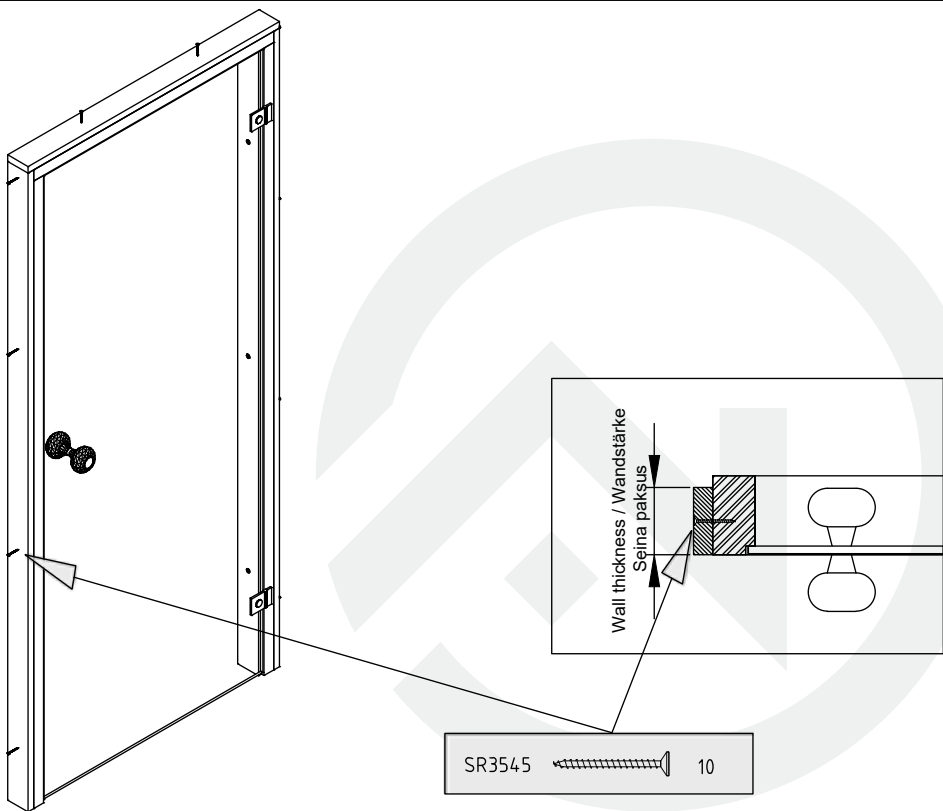

# Türmontage

## Art.-Nr. 350 140

3

Wall thickness / Wandstärke / Seinä paksus 40-44

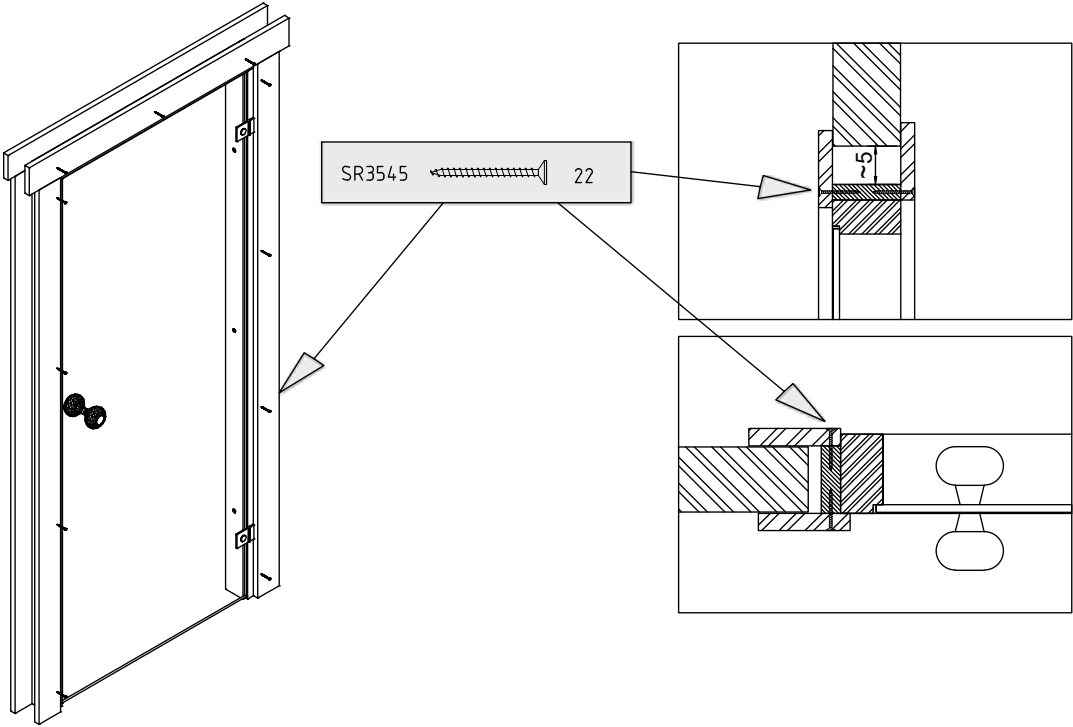

3

Wall thickness / Wandstärke / Seinä paksus 58-92

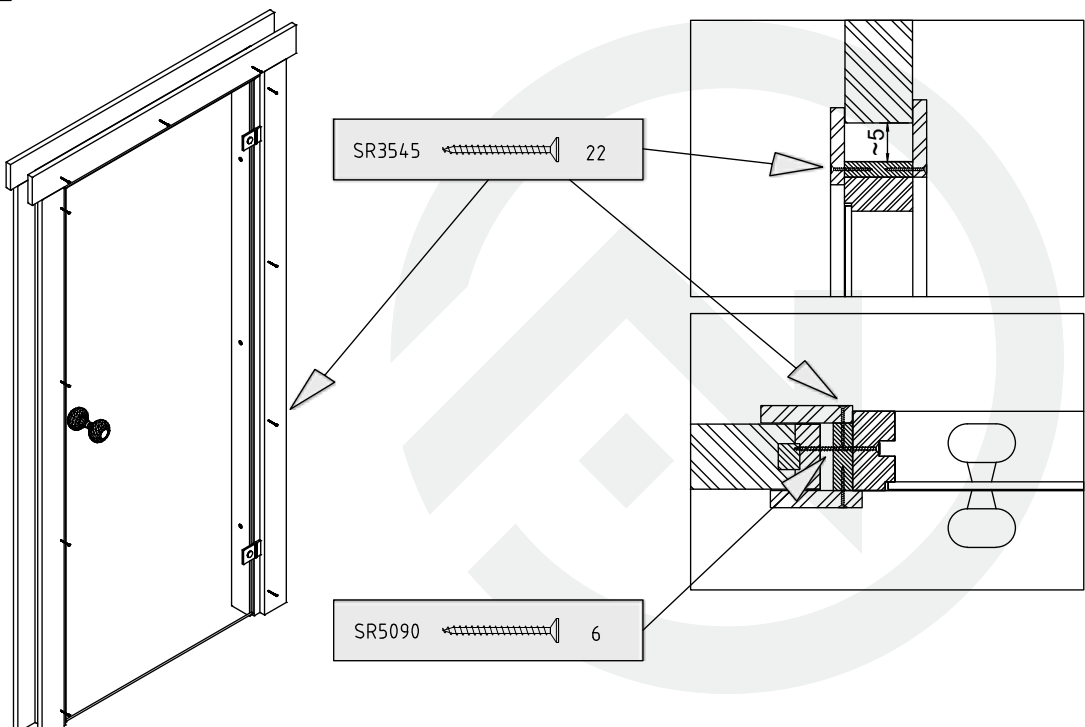

# Einsetzen der Saunabänke Art.-Nr. 350 140

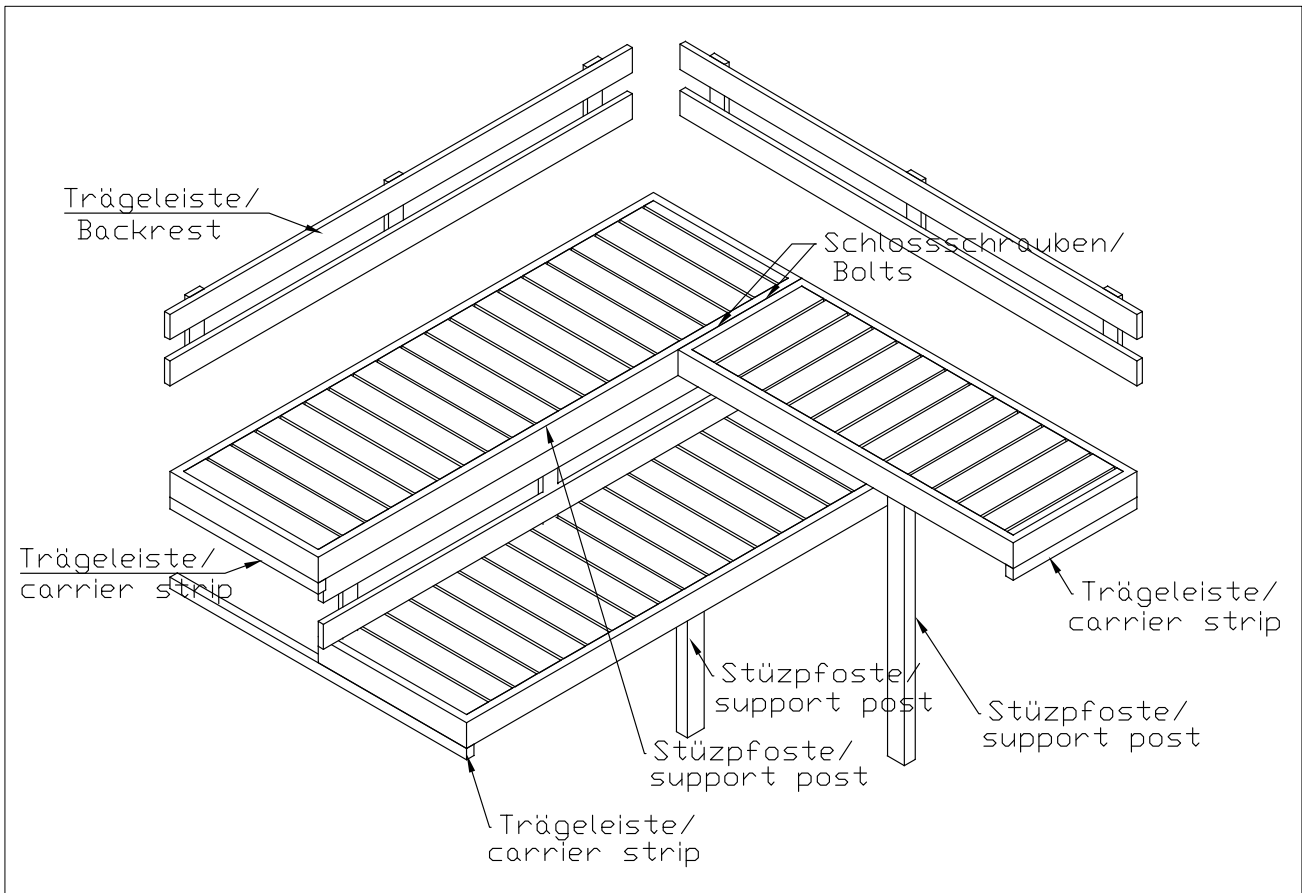



# Montage Bänke und Zwischendecke

## Art.-Nr. 350 140

